

Designation:

**Double swivel single lever mixer tap 3/4“
Stainless steel**

Article number:

221-101/300+300-500
221-101/400+400-500
221-101/500+500-500



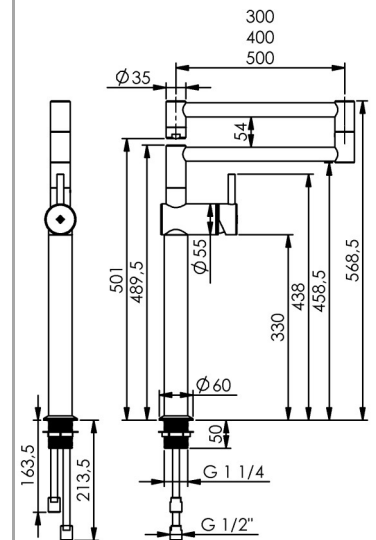
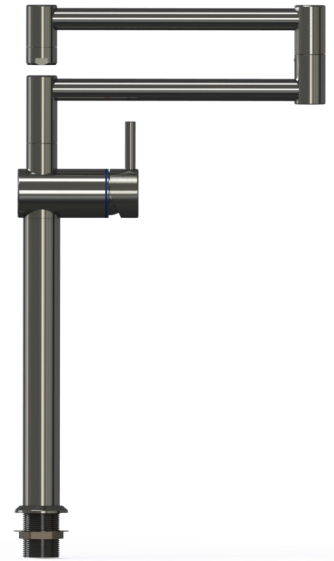

Description:

- Designed for high pressure only, operating pressure 1-6 bar
- Heat insulating handle, lateral
- Double swivel spout with JetSafe (drip stop)
- Projection per arm A = 300 mm / 400 mm / 500mm
- Height under spout H = 500 mm
- Temperature and flow control with modern ceramic cartridge, with high flow
- Connection via 2 x copper pipes with connection thread 1/2“
- Easy-to-install fastening system with fastening nut and nozzle with G 1 1/4“ x 50 mm
- Material **stainless steel**
- Hot water resistant up to 80°C
- Worktop bore hole Ø43 mm

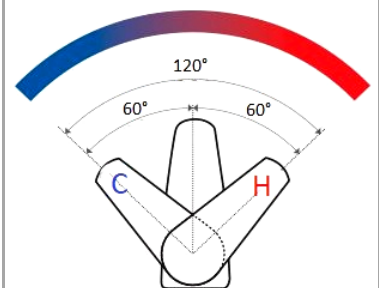
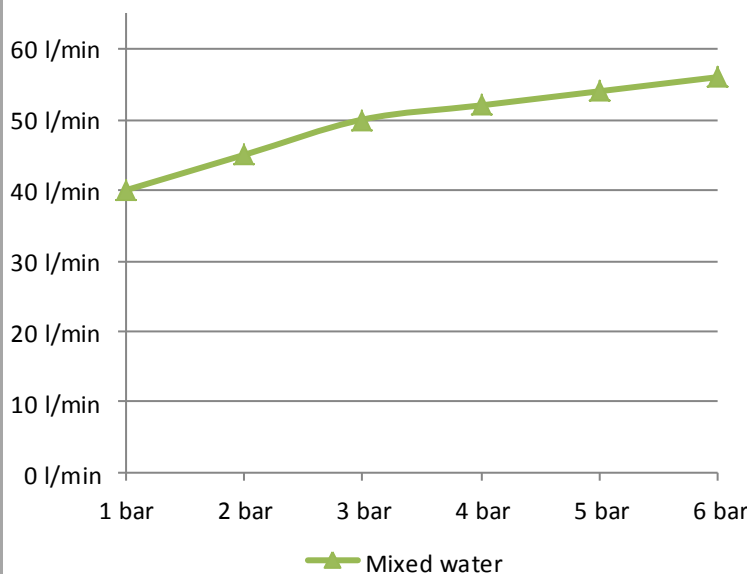

Flow rate:



<p>Proper use:</p>	<p>The pre rinse spray unit is used in commercial kitchens. The fitting must only be operated by trained specialist staff with a minimum age fo 14 years.</p> <p>Assembly or disassembly may only be carried out by certified specialist tradesmen.</p>	
<p>Improper use:</p>	<p>The fitting is not suitable for connection to high pressure systems.</p>	
<p>Hazard warning:</p>	<p>In case of diassembly or repair the angle valves should be shut off.</p>	
<p>Care instructions:</p>	<p>Do not use cleaning agents with a high chlorine or acid content. Refrain from using high-pressure cleaning devices, as defined in work sheet VdF 018, for instance.</p> <p>No types of scouring agents are to be used for cleaning purposes as they scratch the surface.</p>	
<p>Admissions:</p>	<p>All seals meet the requirements for plastics in contact with water and the requirements of DVGW work sheet W 270.</p>	
<p>Manufacturer:</p>	<p>Gebr. Echtermann GmbH & Co.KG P.O. Box 1456 D 58584 Iserlohn</p> <p>Tel: +49 (0) 2371 / 9582-0 Fax: +49 (0) 2371 / 52787 Email: contact@echtermann.de</p>	