

Designation:

**Single-hole mixer tap 3/4" with HU-spout
Stainless steel**

Article number:

221-101/350-355 (A = 350mm; H = 355mm)

221-101/400-355 (A = 400mm; H = 355mm)

221-101/300-355 (A = 300mm; H = 355mm)



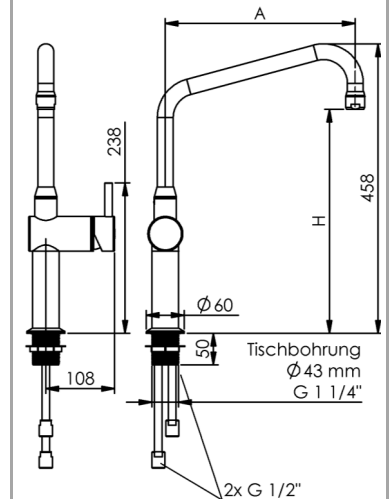

Description:

- Designed for high pressure only, operating pressure 1-6 bar
- Heat insulating handle, lateral
- Swivelling HU-spout with JetSafe (drip stop)
- Projection A = 300 / 350 / 400 mm
- Height H = 355 mm
- Temperature and flow control with modern ceramic cartridge with high flow rate
- Material **stainless steel**
- Hot water resistant up to 80°C
- Worktop bore hole Ø43 mm

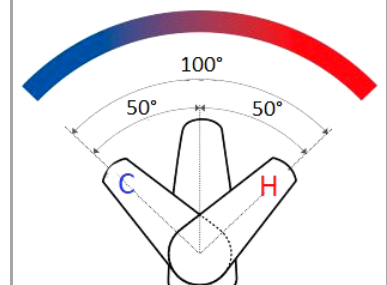
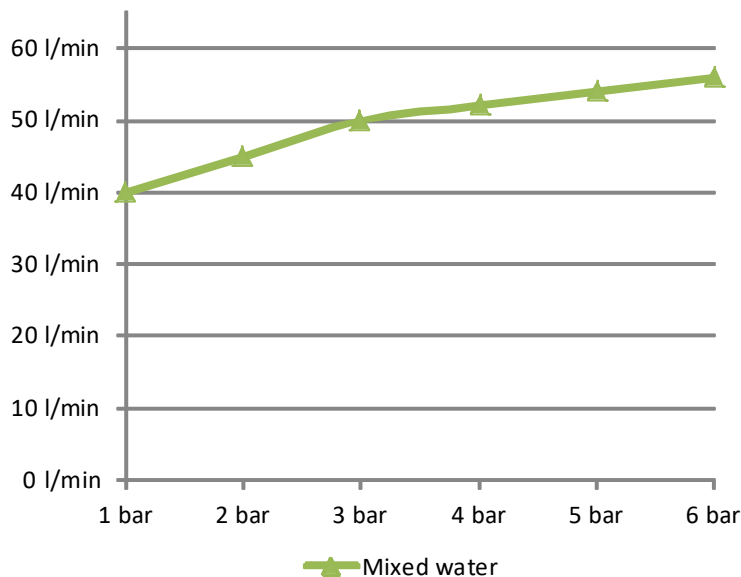

Flow rate:



<p>Proper use:</p>	<p>The pre rinse spray unit is used in commercial kitchens. The fitting must only be operated by trained specialist staff with a minimum age of 14 years.</p> <p>Assembly and disassembly may only be carried out by certified specialist tradesmen.</p>	
<p>Improper use:</p>	<p>The fitting is not suitable for connection to low-pressure hot water boilers.</p> <p>The fitting must not be used to clean push-through dishwashers. There is a risk of damage to the hose from excessive pulling.</p>	
<p>Hazard warning:</p>	<p>In case of disassembly or repair the angle valves should be shut off.</p> <p>In order to prevent water damage, the mixer tap has to be closed outside business hours.</p>	
<p>Care instruction:</p>	<p>Do not use cleaning agents with a high chlorine or acid content. Refrain from using high-pressure cleaning devices, as defined in work sheet VdF 018, for instance.</p> <p>No types of scouring agents are to be used for cleaning purposes as they scratch the surface.</p>	
<p>Admissions:</p>	<p>All seals meet the requirements for plastics in contact with water and the requirements of DVGW work sheet W 270.</p>	
<p>Manufacturer:</p>	<p>Gebr. Echtermann GmbH & Co.KG P.O. Box 1456 D 58584 Iserlohn</p> <p>Tel: +49 (0) 2371 / 9582-0 Fax: +49 (0) 2371 / 52787 Email: contact@echtermann.de</p>	